

Thank you for purchasing this air funnel . Please read the instructions , they are there for a purpose.

### ATTENTION

1. Upon installation make sure the enviroment is clean as it will affect its precision.
2. In the course of adjusting and disassembling , if the item is damaged , we as manufacturers will not take responsibility.
3. This manual is divided into four parts which is dimensions , accesories included , optional accesories and specifications.

### 1-1 DIMENSIONS

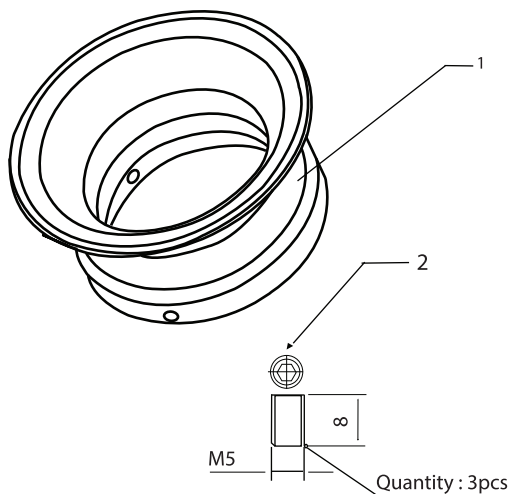
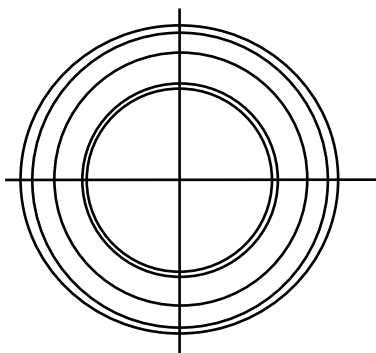
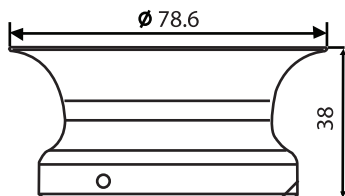
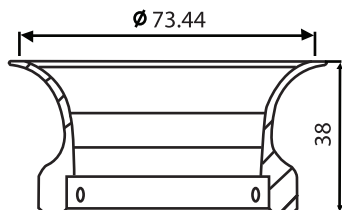

## 1-2 ACCESSORIES INCLUDED

1

AIR FUNNEL X 1

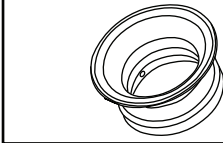

2

SCREW ( M5 X 3 )

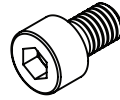

## 1-3 OPTIONAL ACCESSORIES

1

CARBURETOR

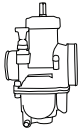

**28MM/ 4T :** 02C00390

**30MM/ 2T :** 02C00400

**30MM/ 4T :** 02C00510

## 1-4 SPECIFICATIONS

- 1 . Camshaft proritized for racing use but also applicable for daily use.
- 2 . Customized design to maximize power.
- 3 . Structure designed to endure both vibration and extreme heat.
- 4 . Race tested for performance and durability.
- 5 . For all carburetor models .